

Article number: 390218501554010

Description: Worm gear  
VF 185-FC2-15-100B5, without lubrication

## Measures

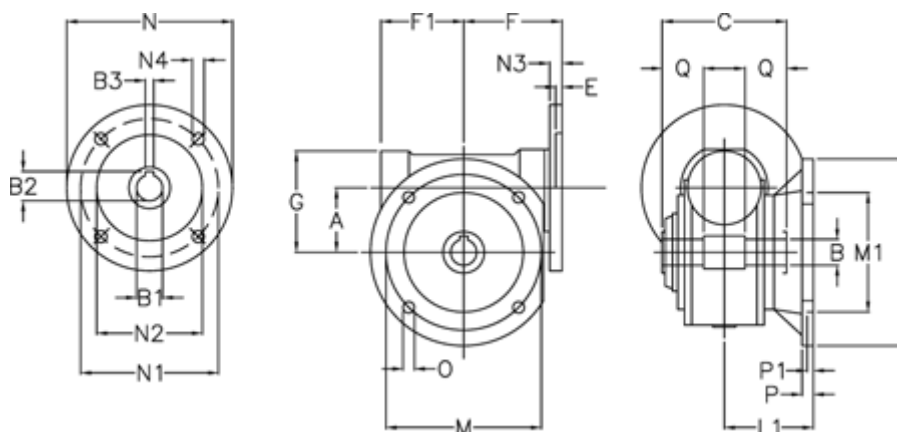

A	= 185.4	F1	= 205	N2	= 180
B	= 60 H7	G	= 267	N3	= 16
B1	E7 = 28	L	= 400	N4	= 13
B2	= 31.3	L1	= 155.5	O	= 22
B3	H9 = 8	M	= 350	P	= 22
C	= 190	M1	= 280	P1	= 13
E	= 4	N	= 250	Q	= 65
F	= 217	N1	= 215		